



EVOTECH®
P E R F O R M A N C E

www.evotech-performance.com

Ducati DesertX Ultimate Addons
Sat Nav Mount



Kit Contents

- Ⓐ 1 x Main Plate
 - Ⓑ 1 x Pivot Plate
 - Ⓒ 1 x Sub Mounting Bracket
 - Ⓓ 2 x M5 x 8mm Black Button Head Bolts
 - Ⓔ 2 x P-clips (No.1)
 - Ⓕ 2 x P-clips (No.2)
 - Ⓖ 2 x P-clips (No.3)
 - Ⓗ 2 x P-clips (No.4)
 - Ⓘ 2 x Lobe Screw
 - Ⓙ 2 x M5 Black Washer
 - Ⓚ 2 x Locking Washer
 - Ⓛ 2 x M4 x 5mm Black Button Head Bolts
- Sub Kit
- ⒶⒶ 1 x Spacer (Short Spacer)
 - ⒷⒷ 1 x M6 x 35mm Black Button Head
 - ⒸⒸ 2 x Spacer (Long Spacer)
 - ⒹⒹ 2 x M6 x 45mm Black Button Head



Repeat
Both Sides

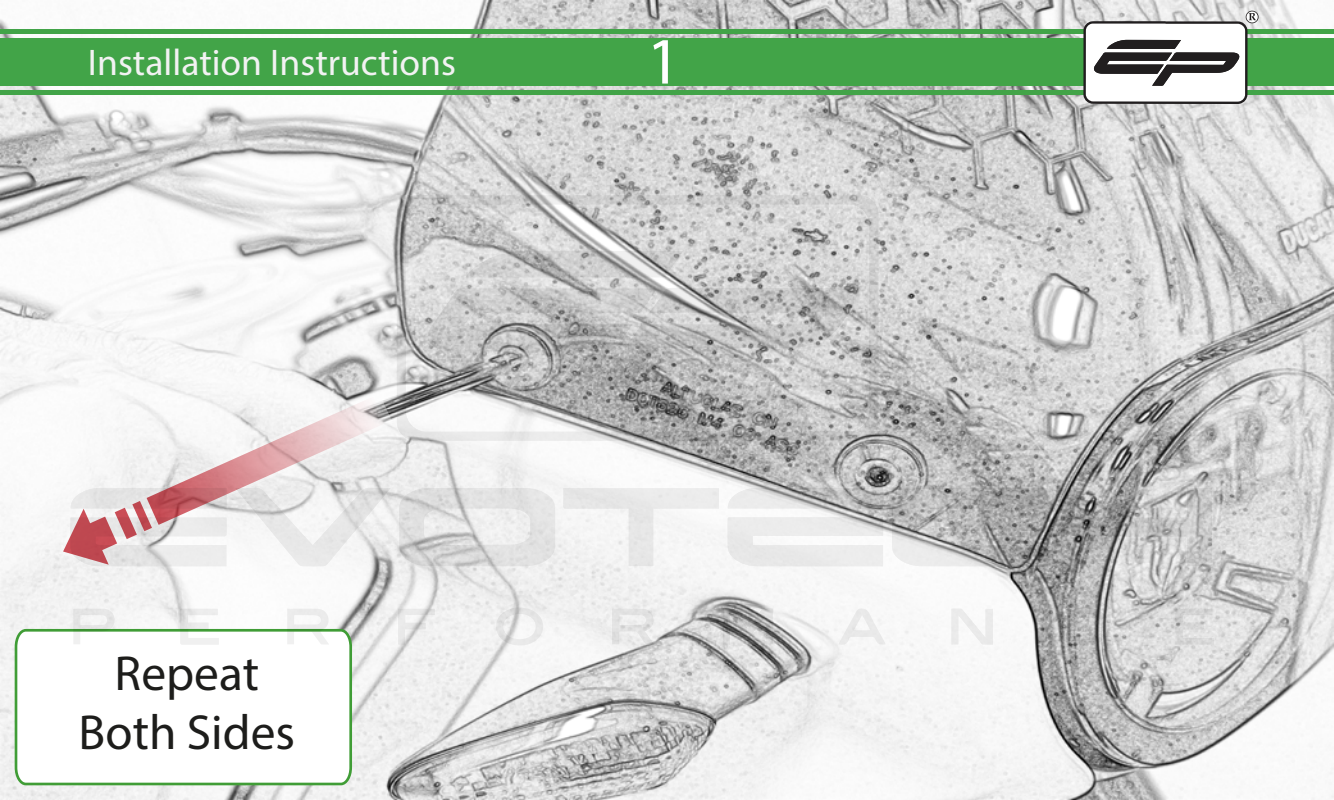

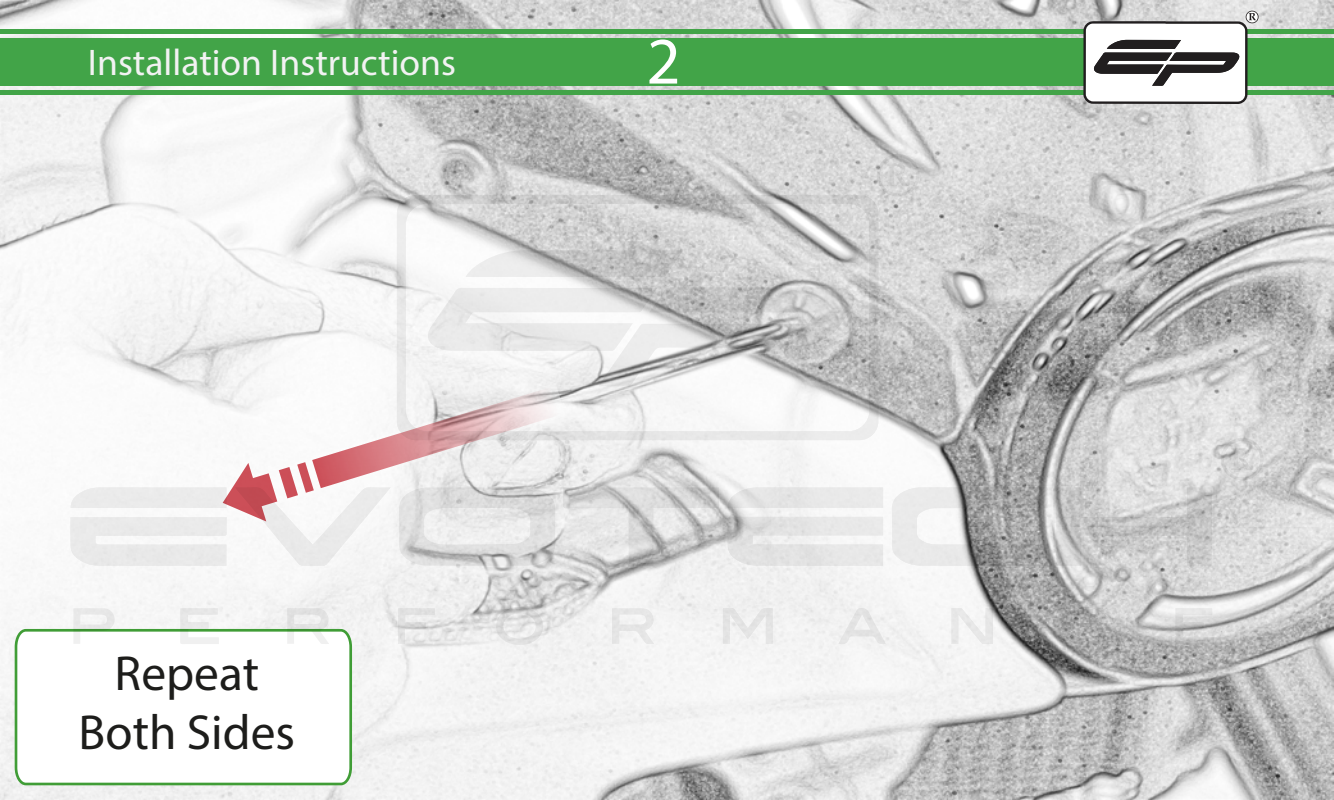

Repeat
Both Sides

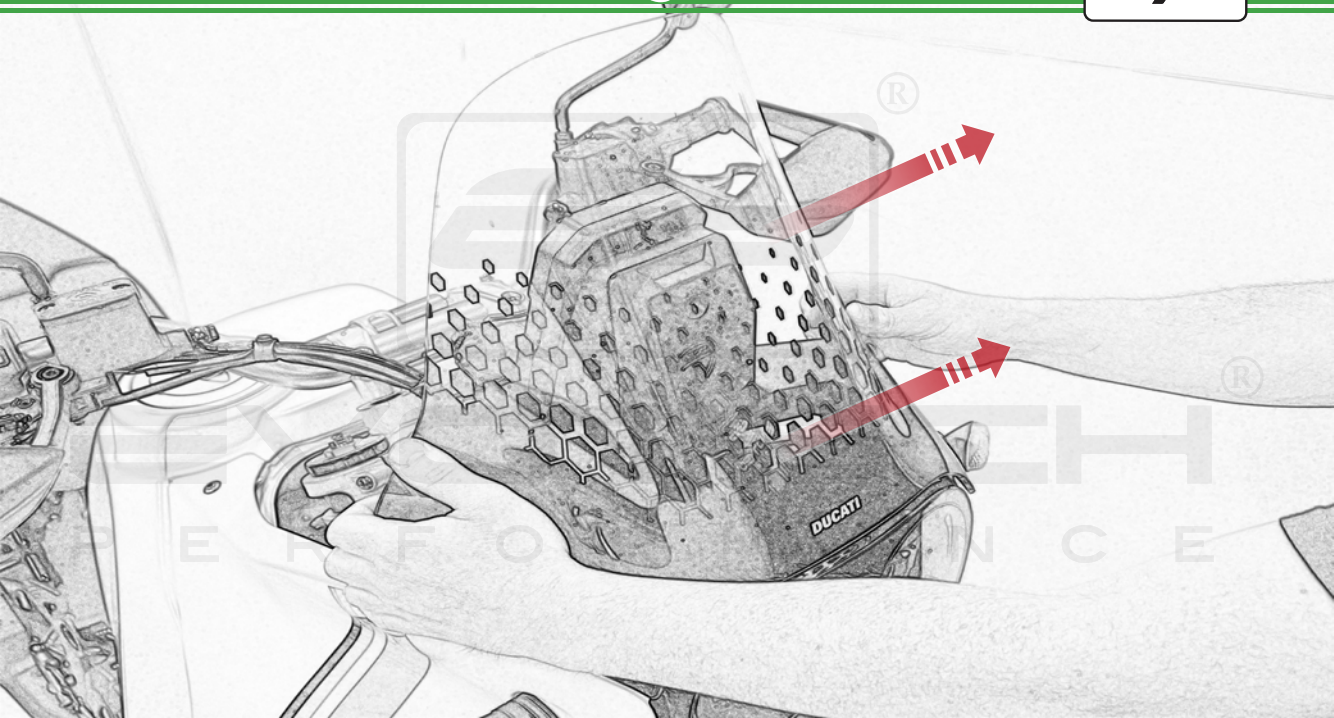

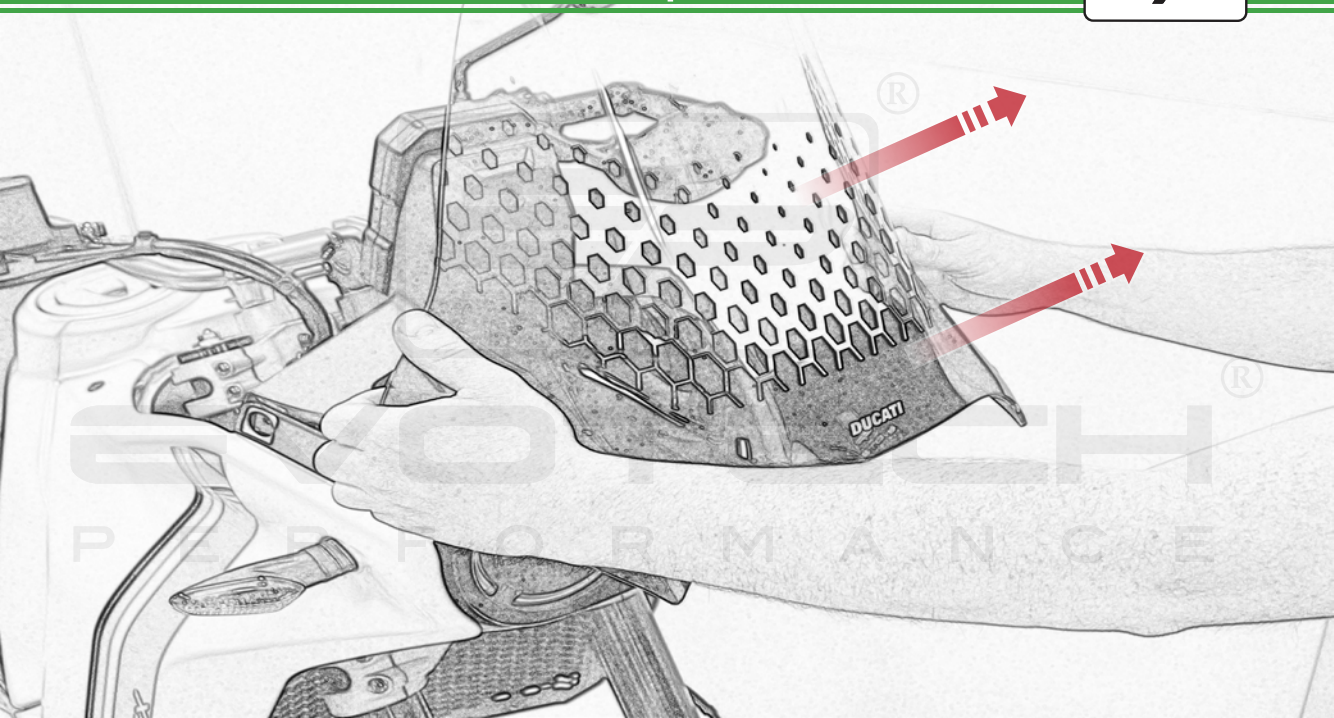

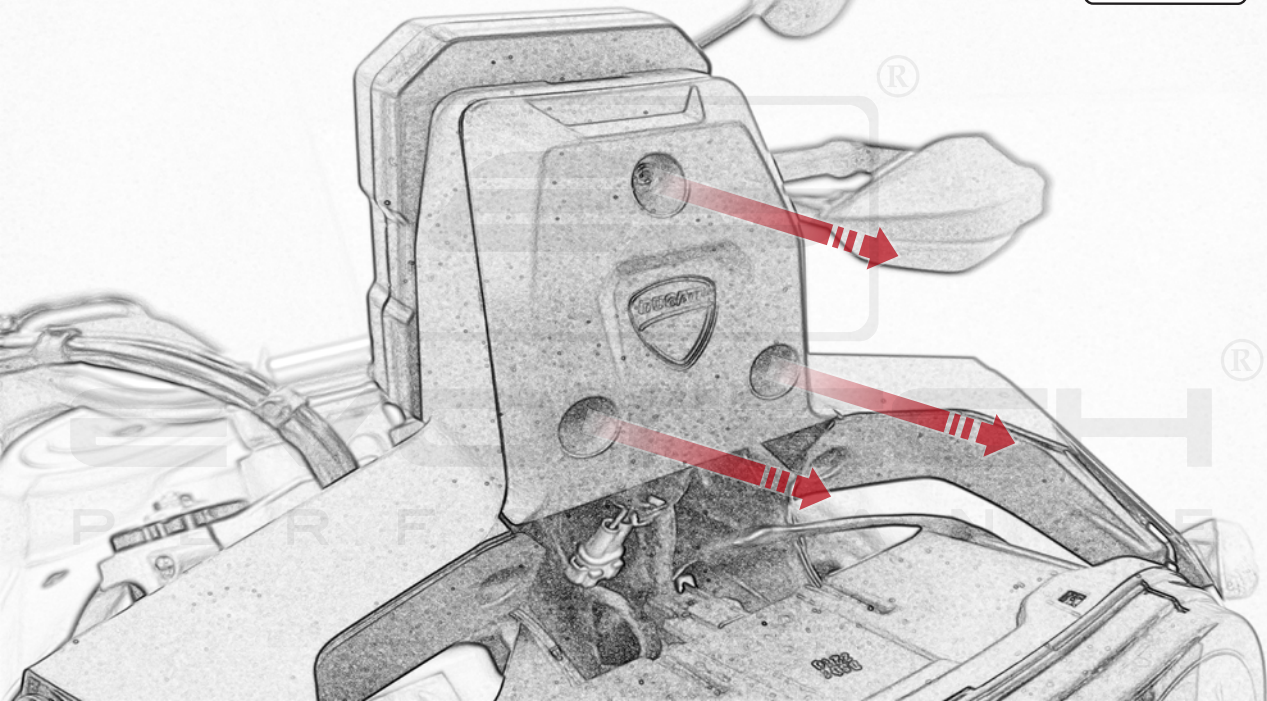



This is optional

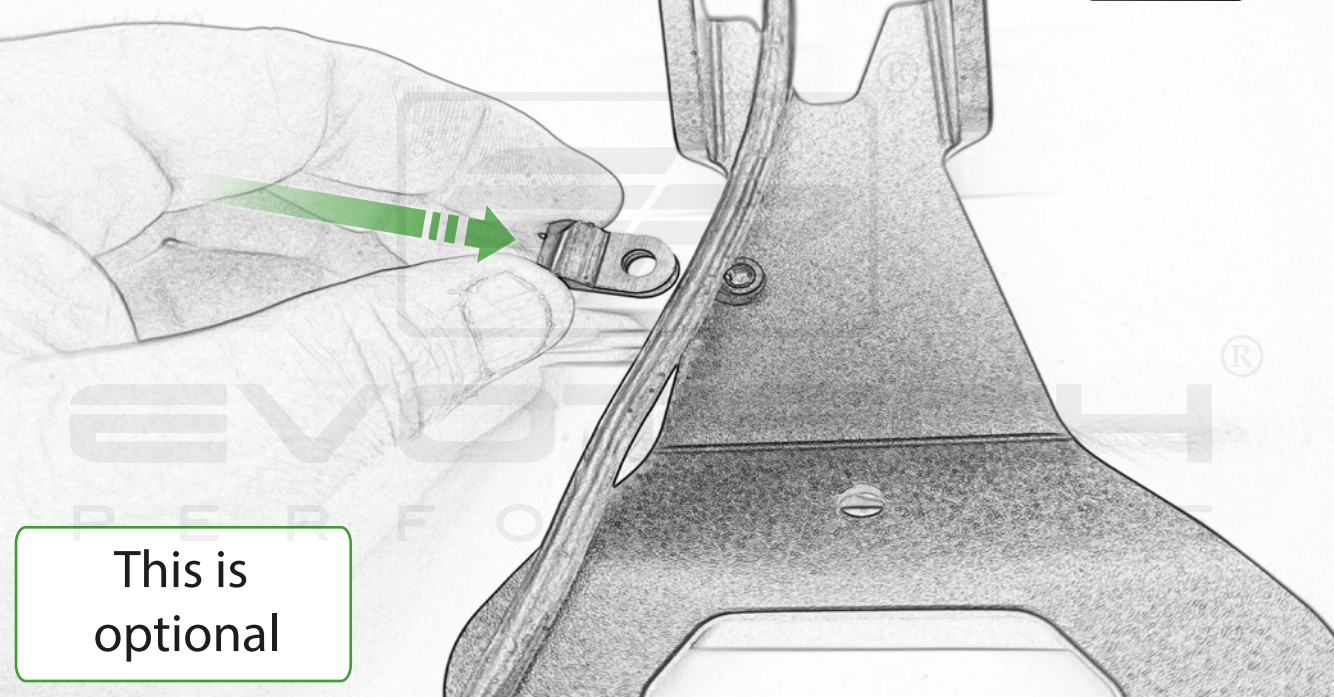

This is
optional



L

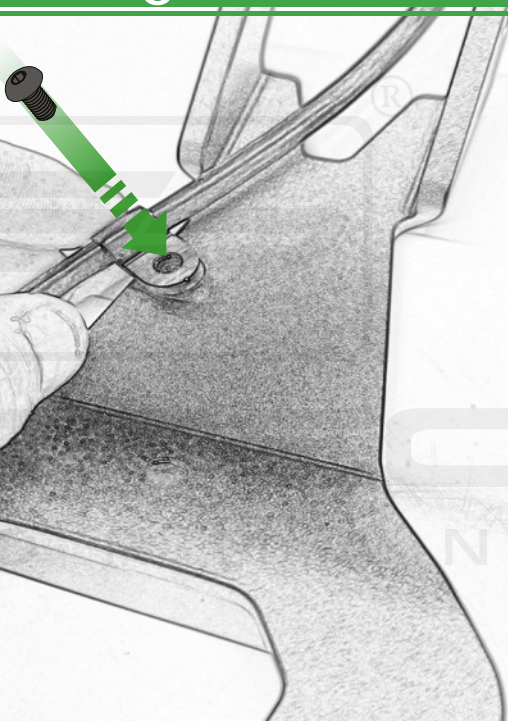

This is optional

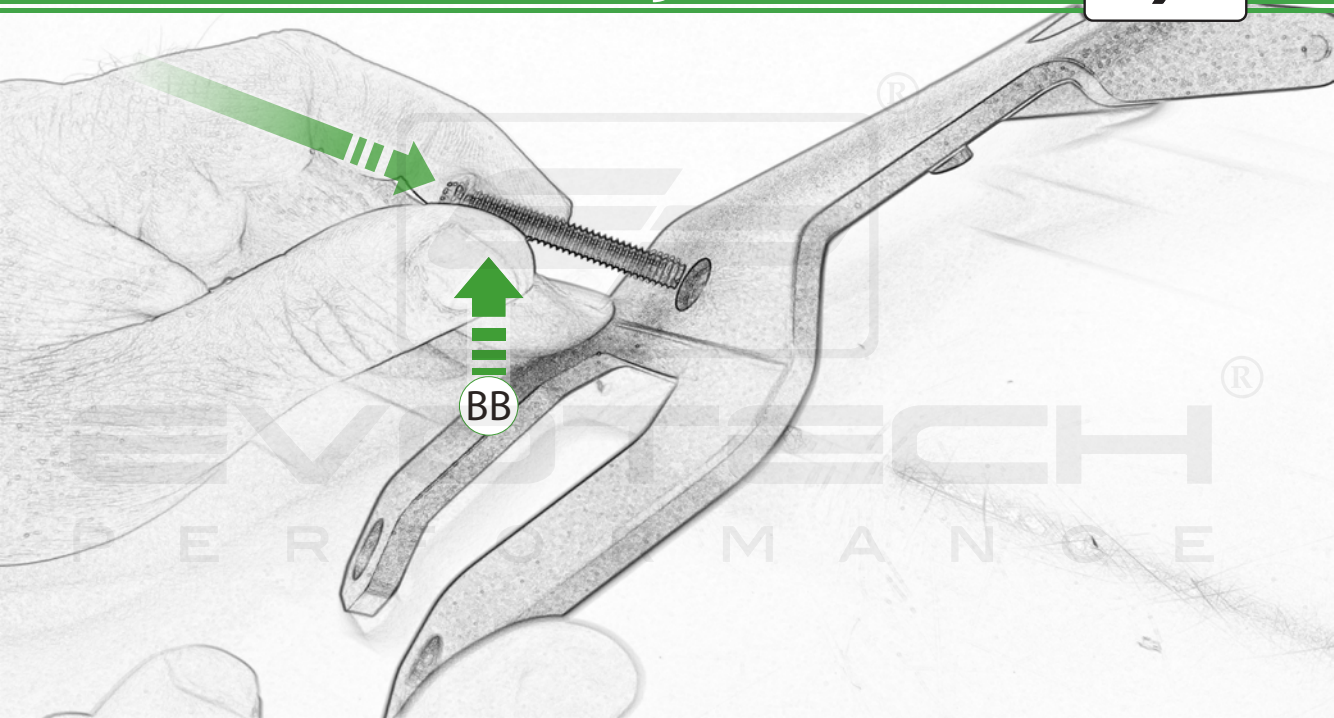

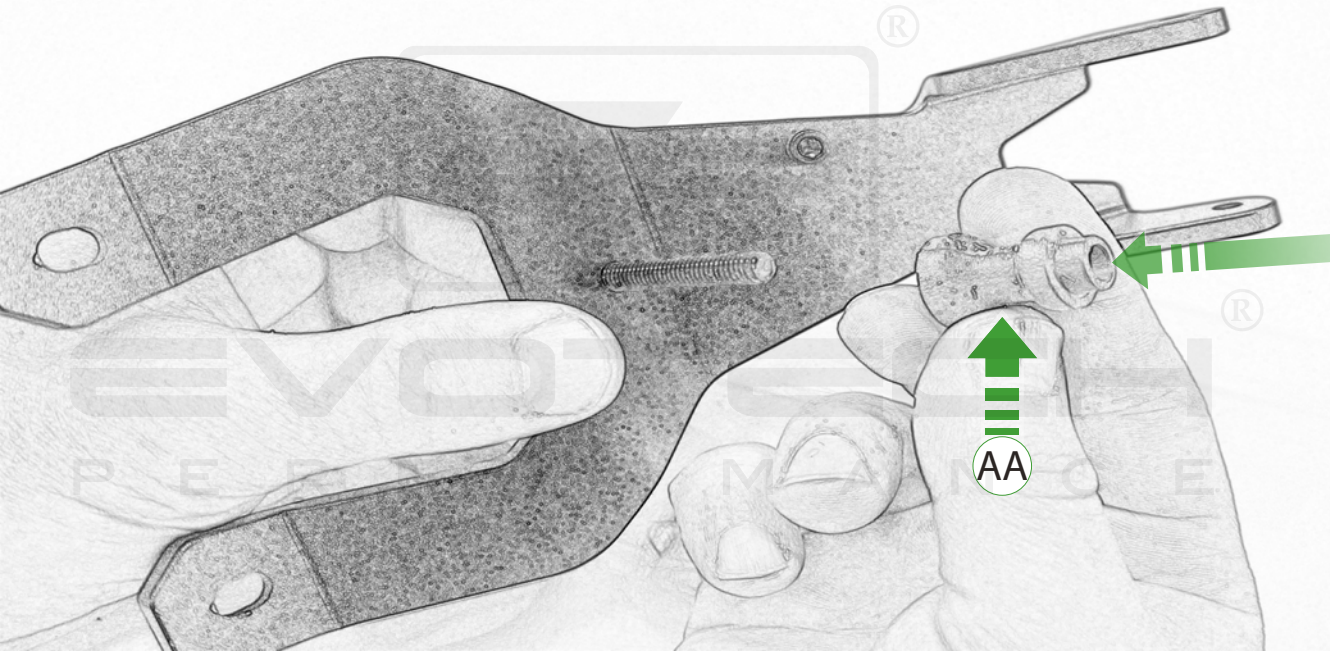

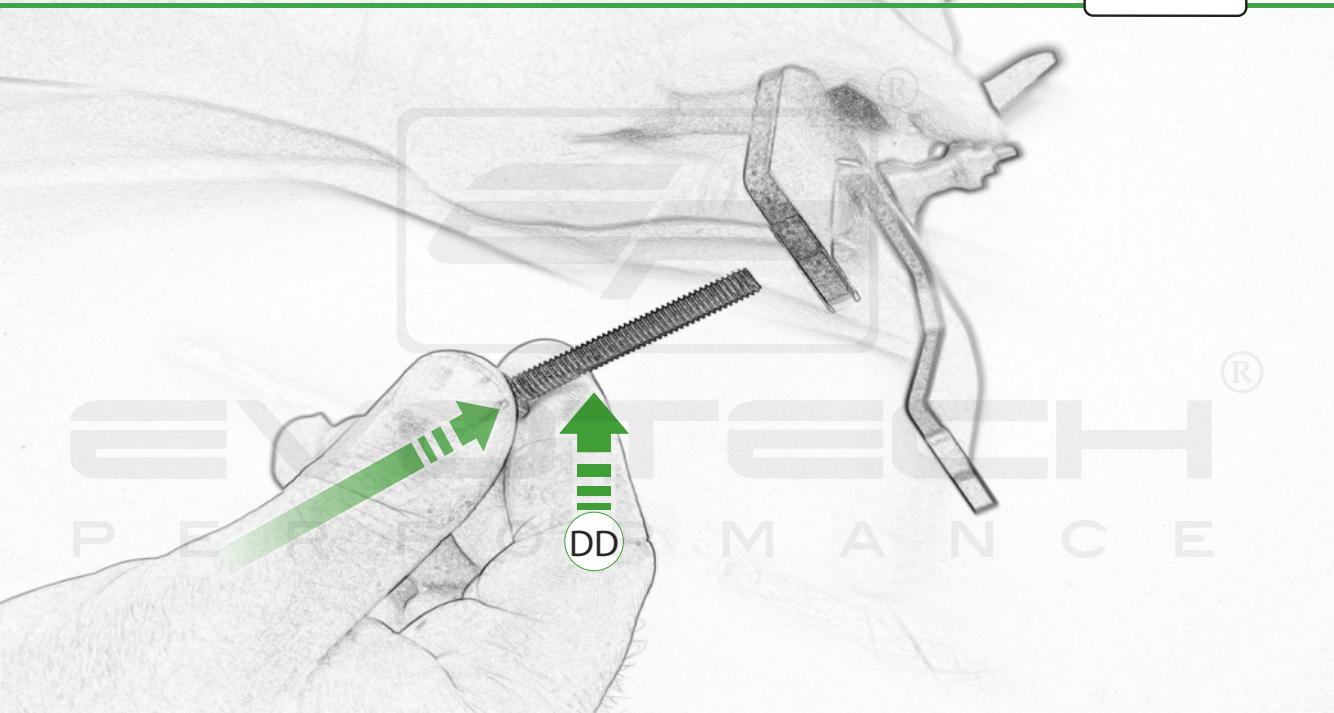

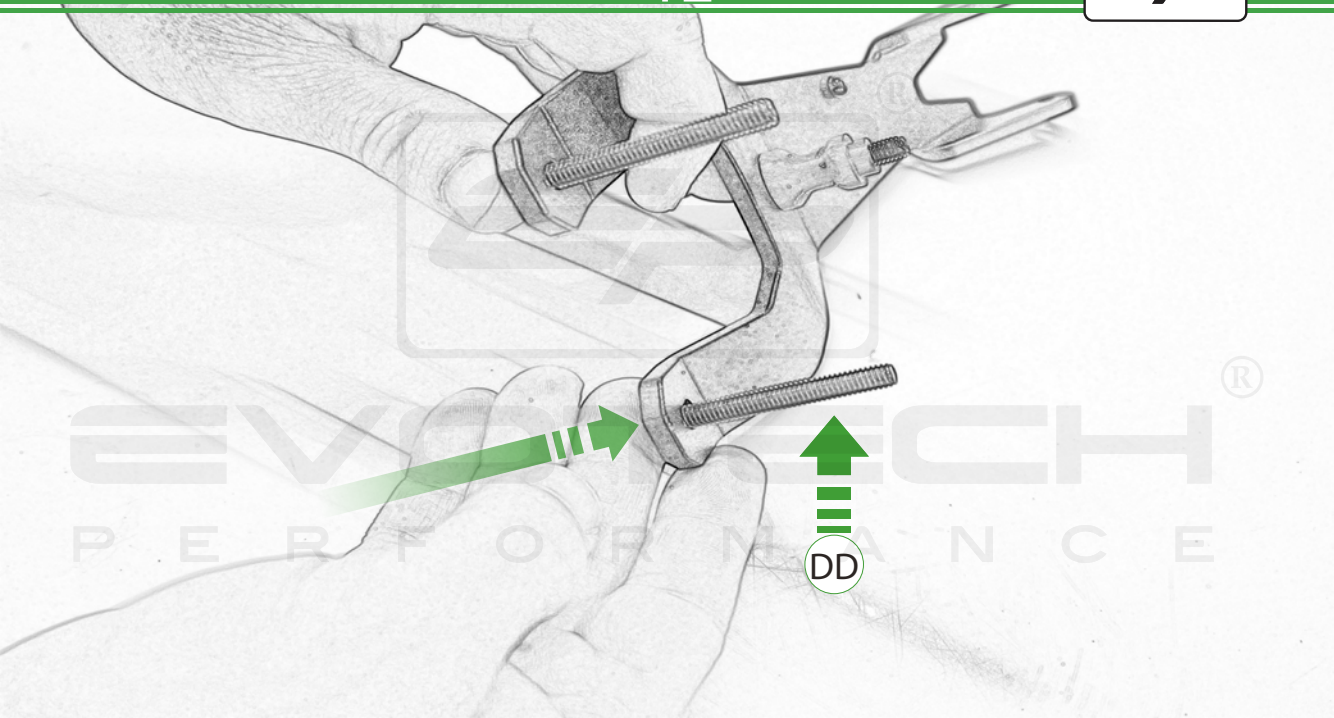

DD

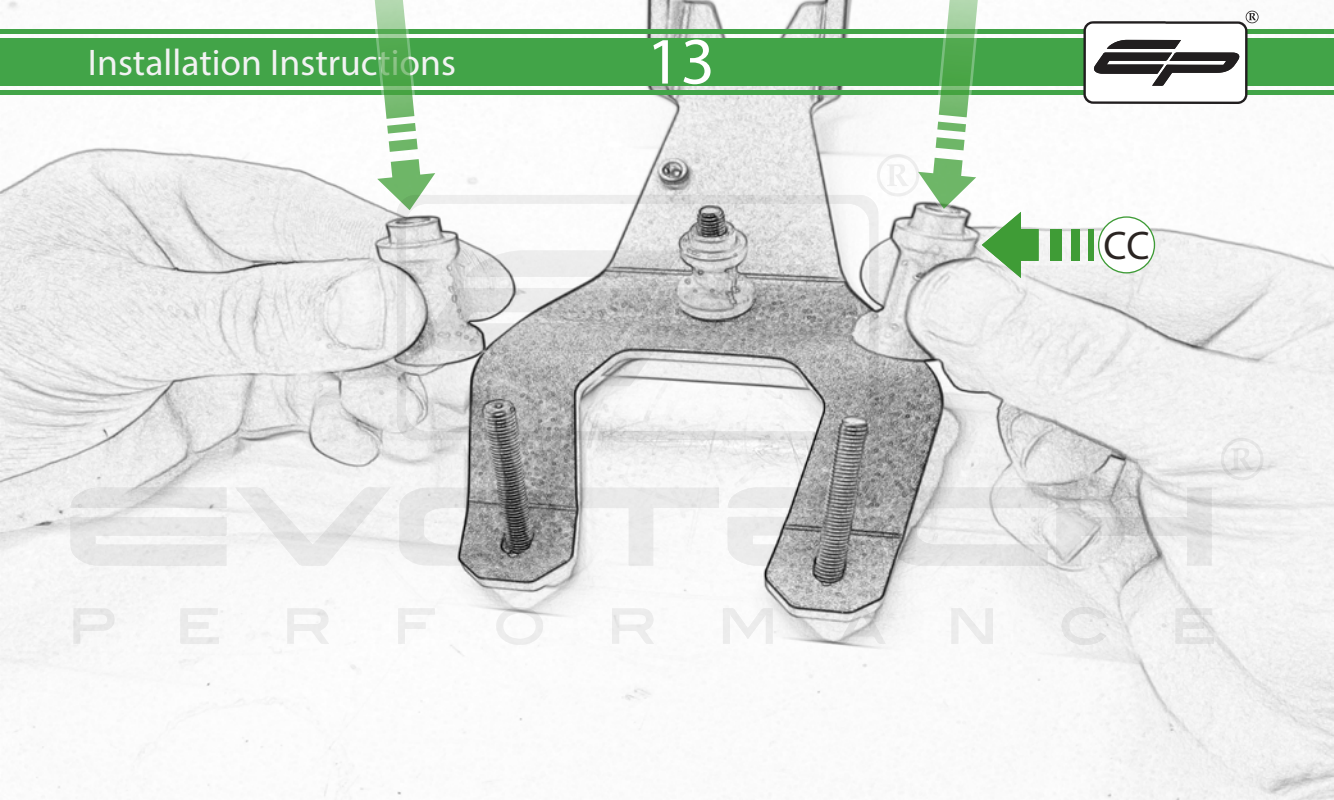

EVERTECH
PERFORMANCE

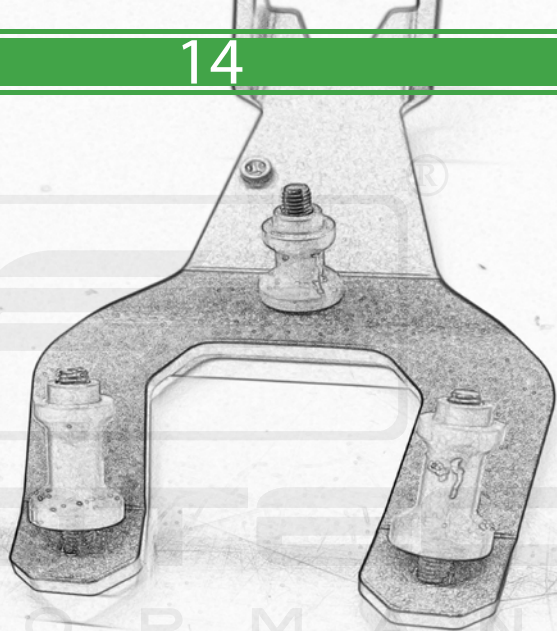

EVEREADY[®]
PERFORMANCE[®]



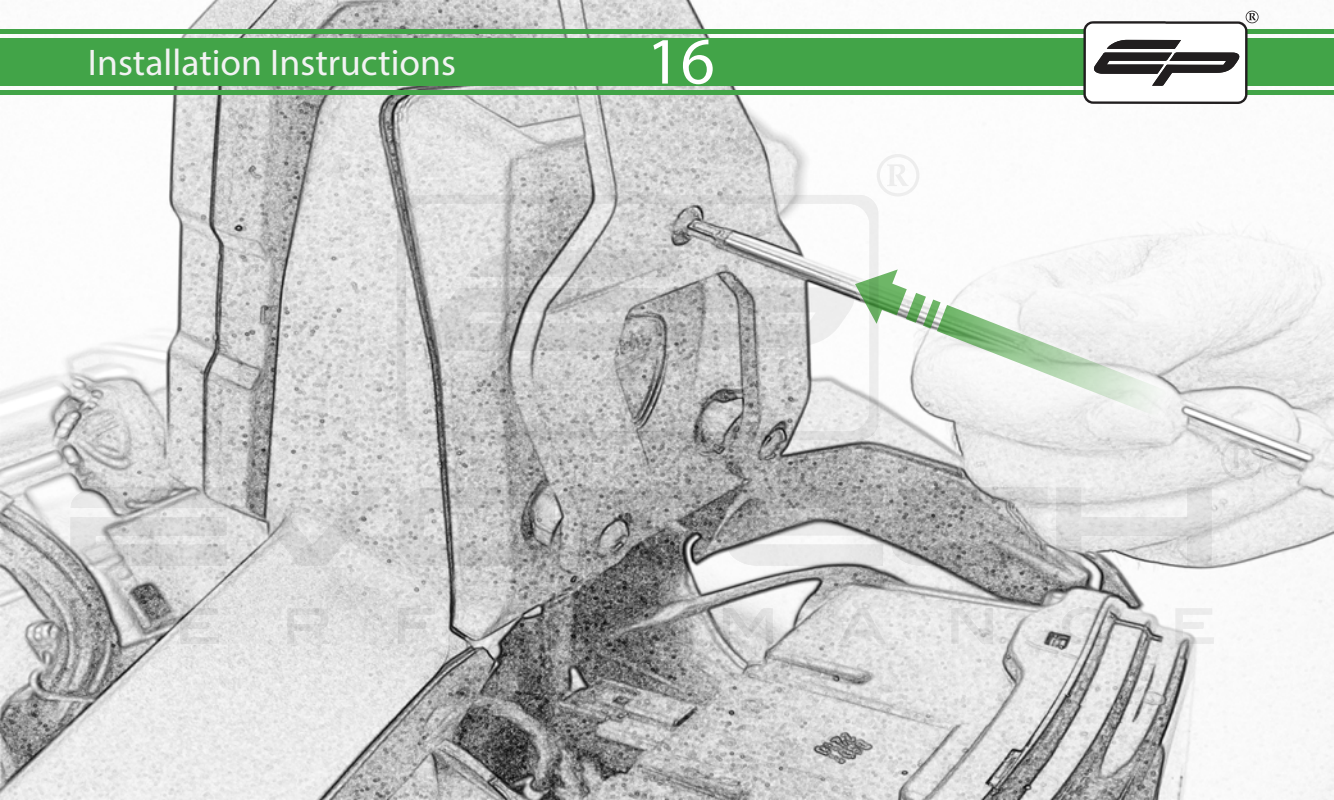

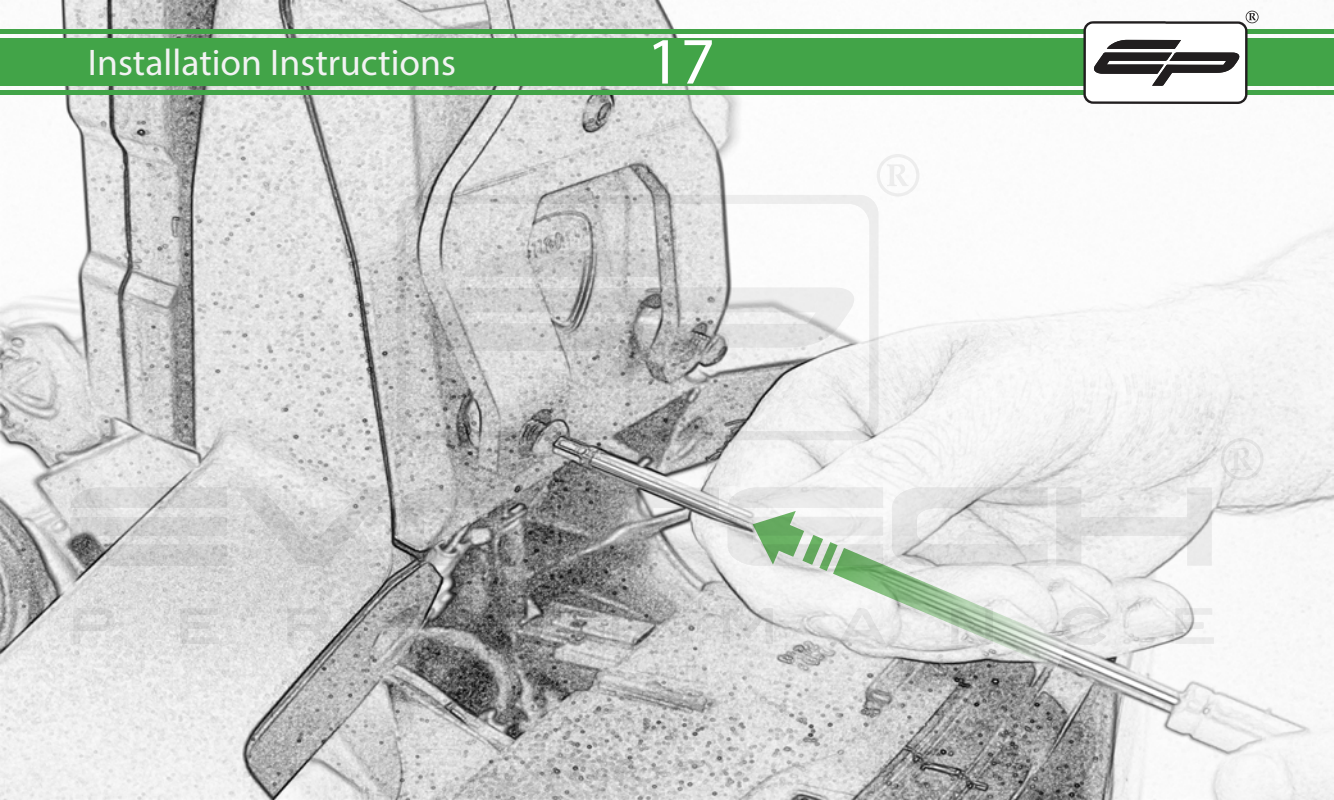

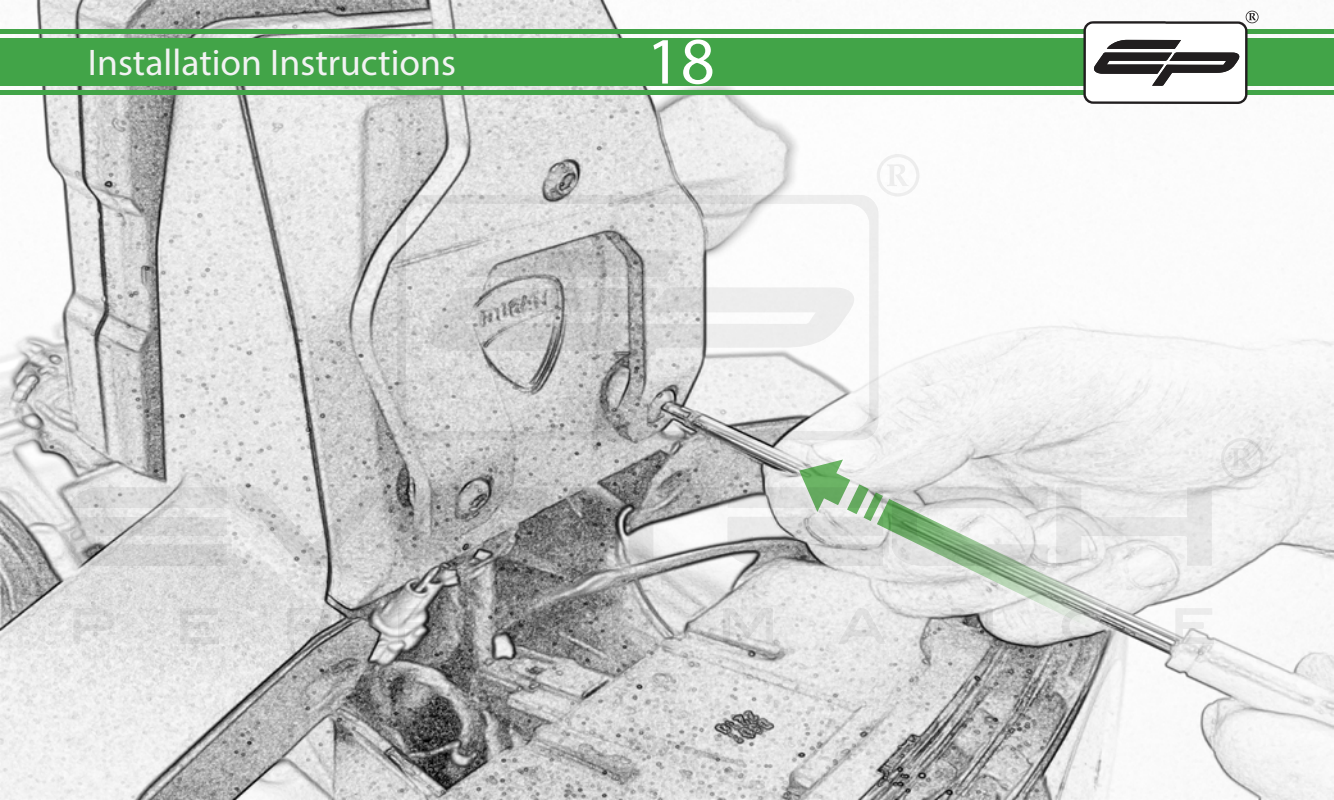



EVOTECH[®]

P E R F O R M A N C E



D

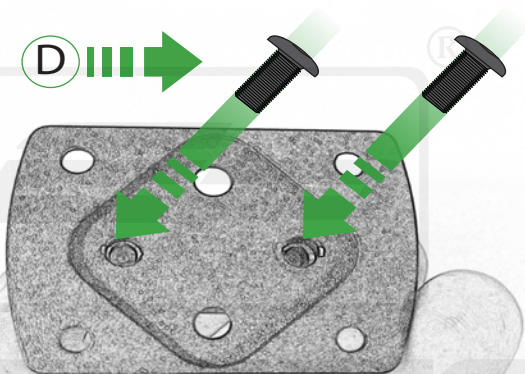

EVERTECH[®]
PERFORMANCE

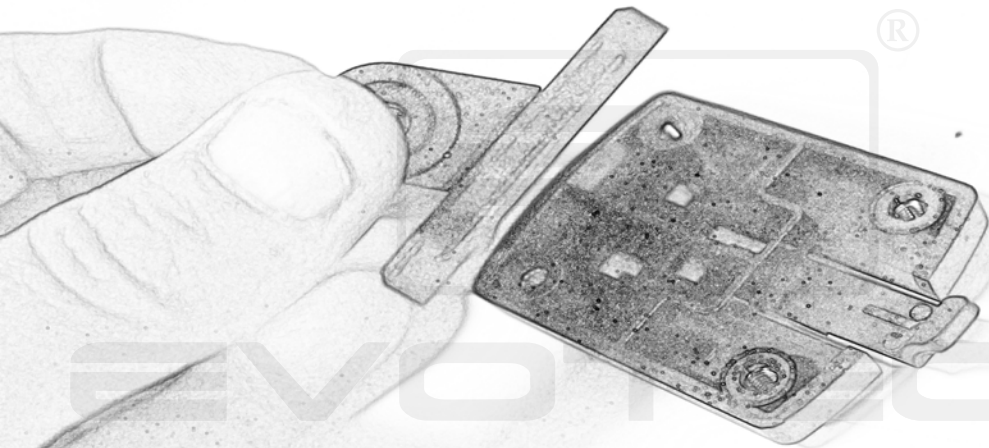

P E R F O R M A N C E



OEM PART 

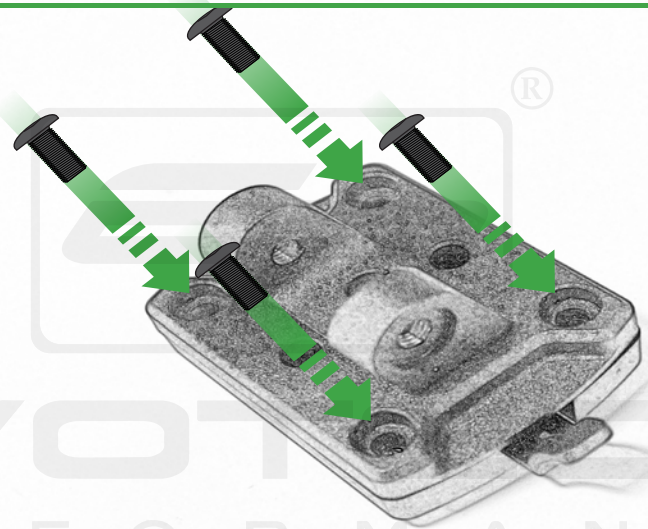

EVOTECH[®]
PERFORMANCE

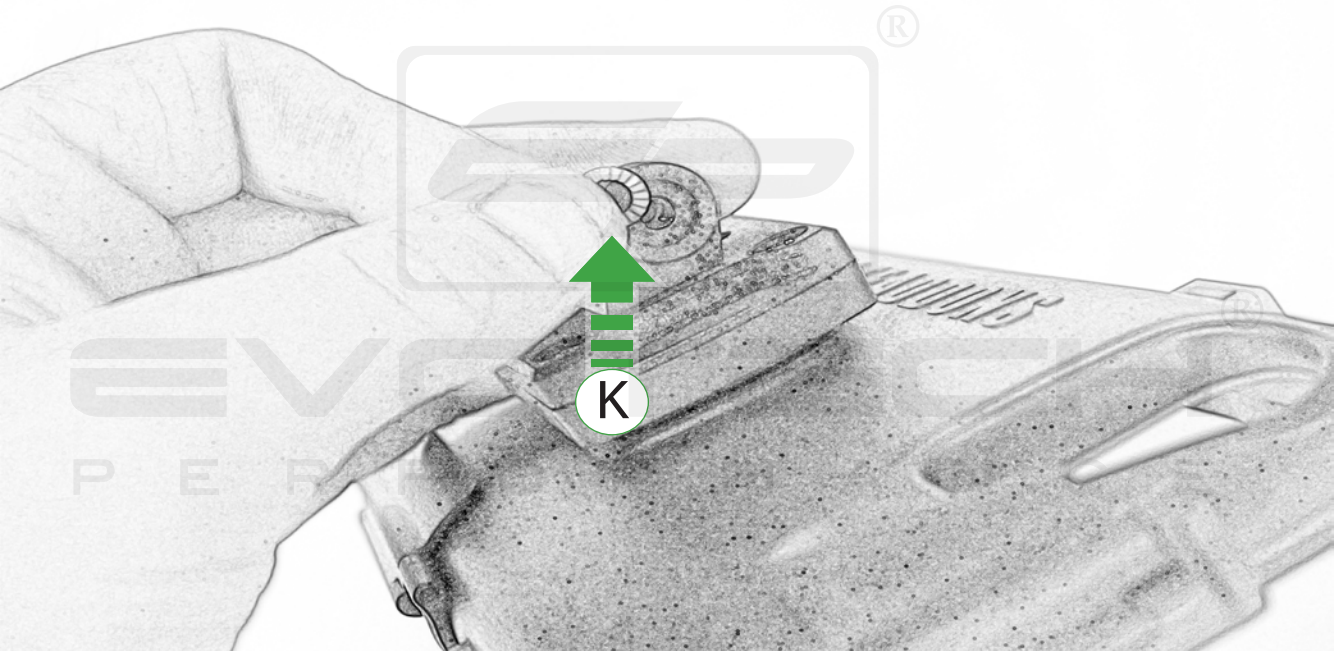

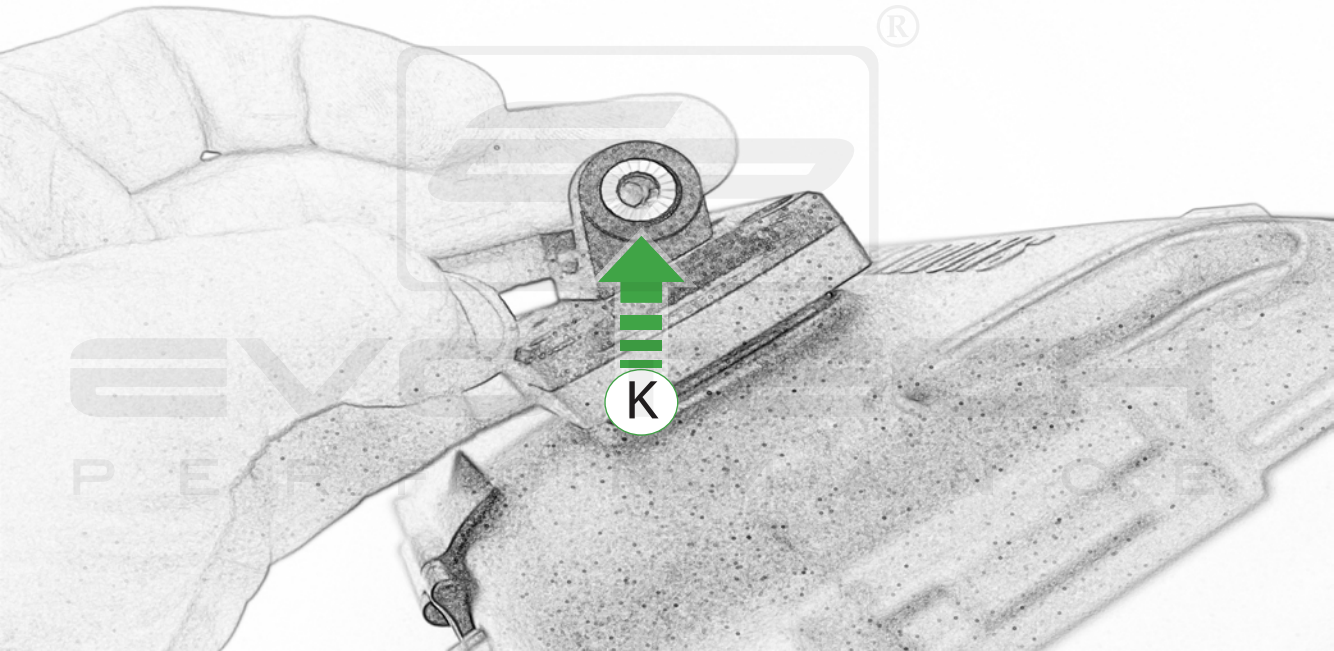

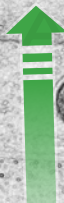
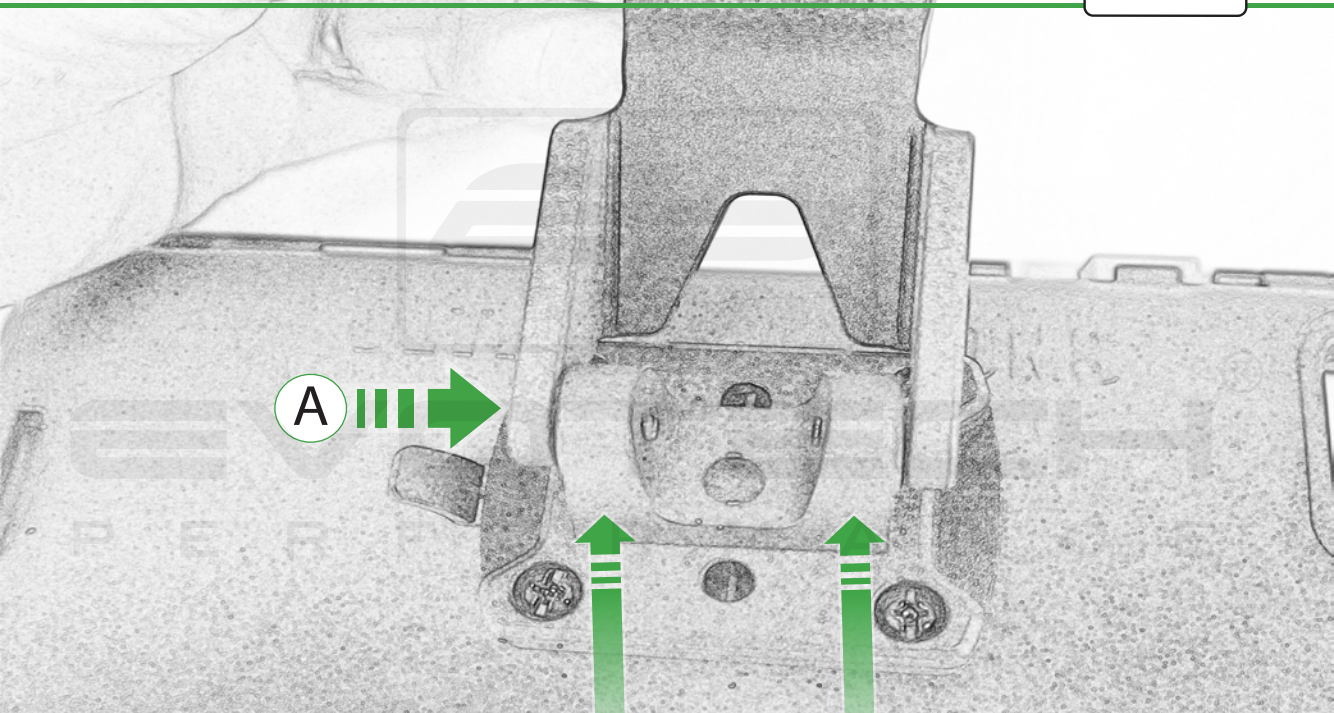

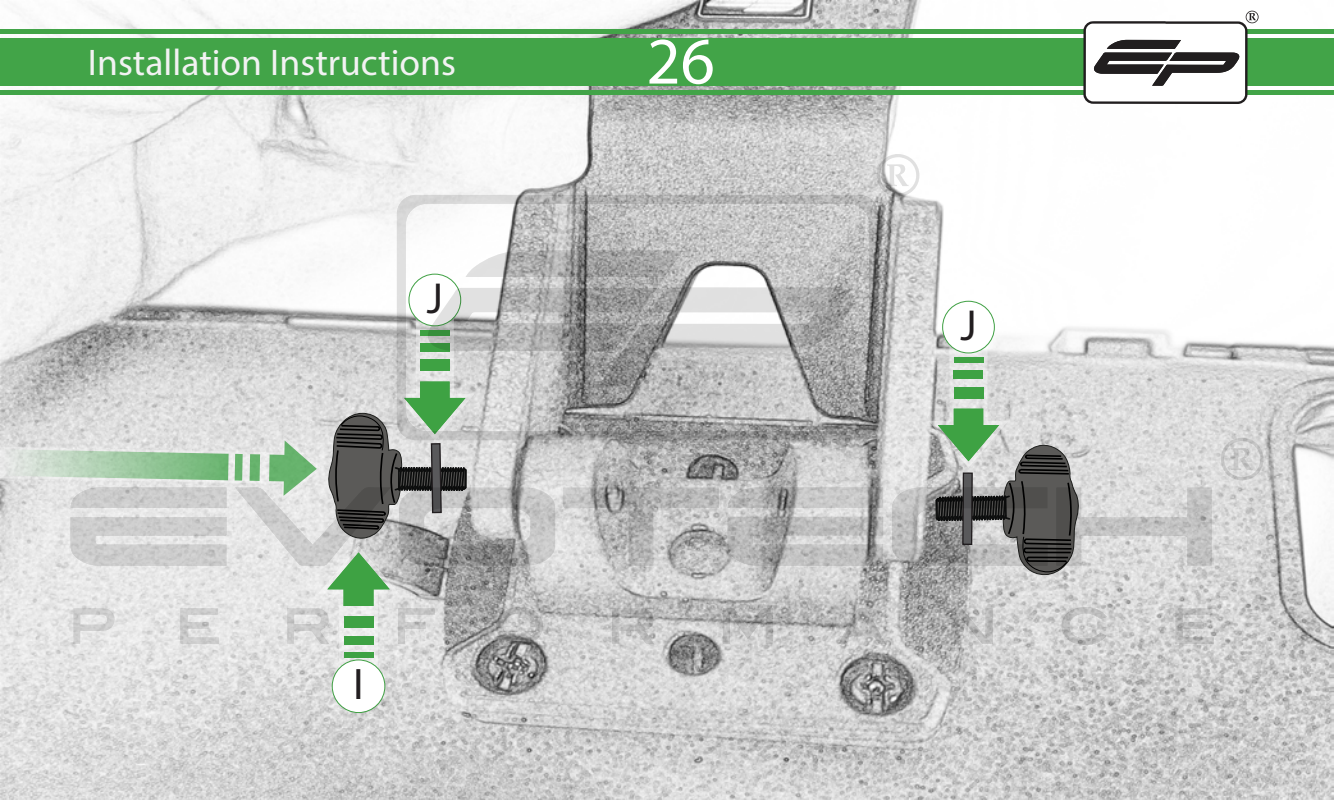

J

J

I



ESSENTIAL CHECKS

It is recommended that periodic inspections are made to ensure that all bolts are tightened to the specified torque settings.

Should the bike be involved in an accident a thorough inspection should be made and any components that have taken an impact, no matter how small, be replaced

P E R F O R M A N C E



EVOTECH®
P E R F O R M A N C E

www.evotech-performance.com